

Serial Comm®
Data Conversion Experts

MODEL: CON-485-PIE

DESCRIPTION: Industrial RS232 to RS485 (4-Position Terminal Block)

SCALE: 1:1

UNIT: mm

ISSUE DATE: 11/07/2016

REV. NO.: 1.00

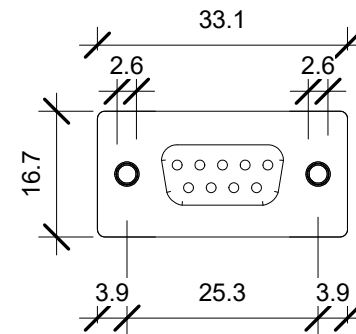
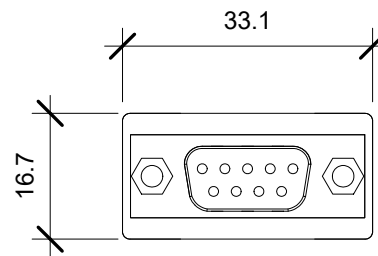
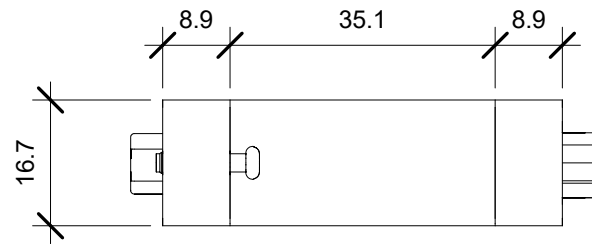
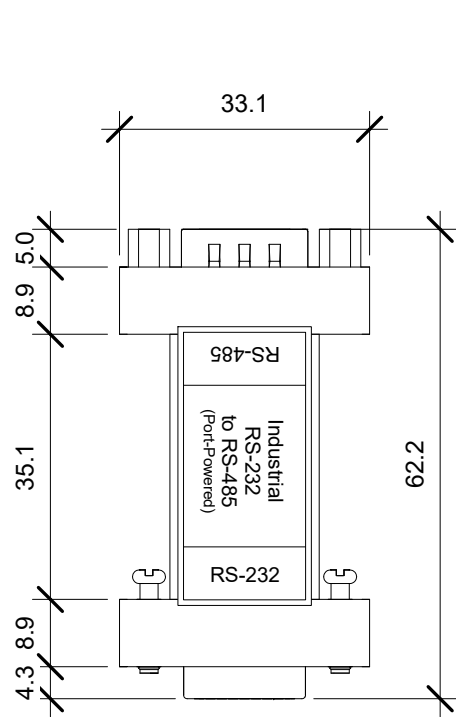

Serial Comm®
Data Conversion Experts

MODEL: CON-485-PIE

DESCRIPTION: Industrial RS232 to RS485 (No Terminal Block)

SCALE: 1:1

UNIT: mm

ISSUE DATE: 11/07/2016

REV. NO.: 1.00

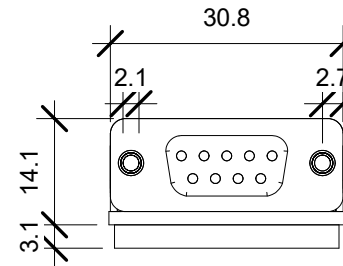
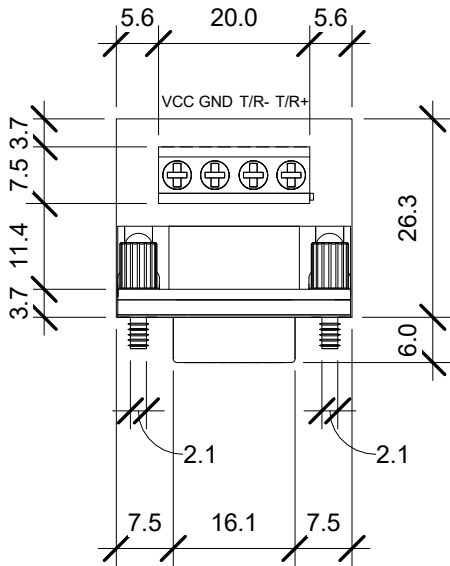
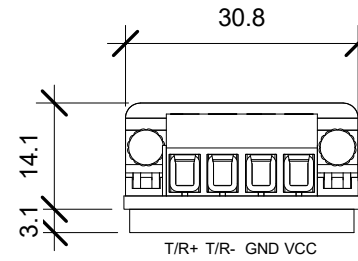
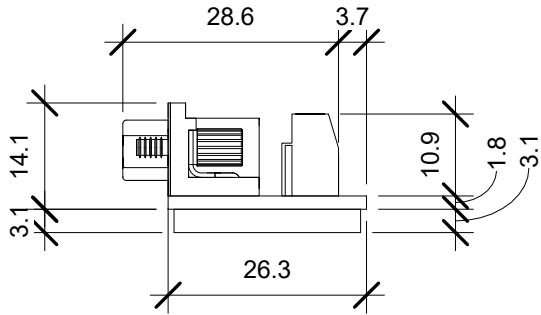

Serial Comm®
Data Conversion Experts

MODEL: CON-485-PIE

DESCRIPTION: 4-Position Terminal Block

SCALE: 1:1

UNIT: mm

ISSUE DATE: 11/07/2016

REV. NO.: 1.00