

MODEL: SER-FIBER-SM-ST	
DESCRIPTION: Industrial RS-232/RS-485/RS-422 to Fiber Optic with Terminal Blocks (SM ST)	
SCALE: 1:1	UNIT: mm
ISSUE DATE: 03/05/2017	REV. NO.: 1.00

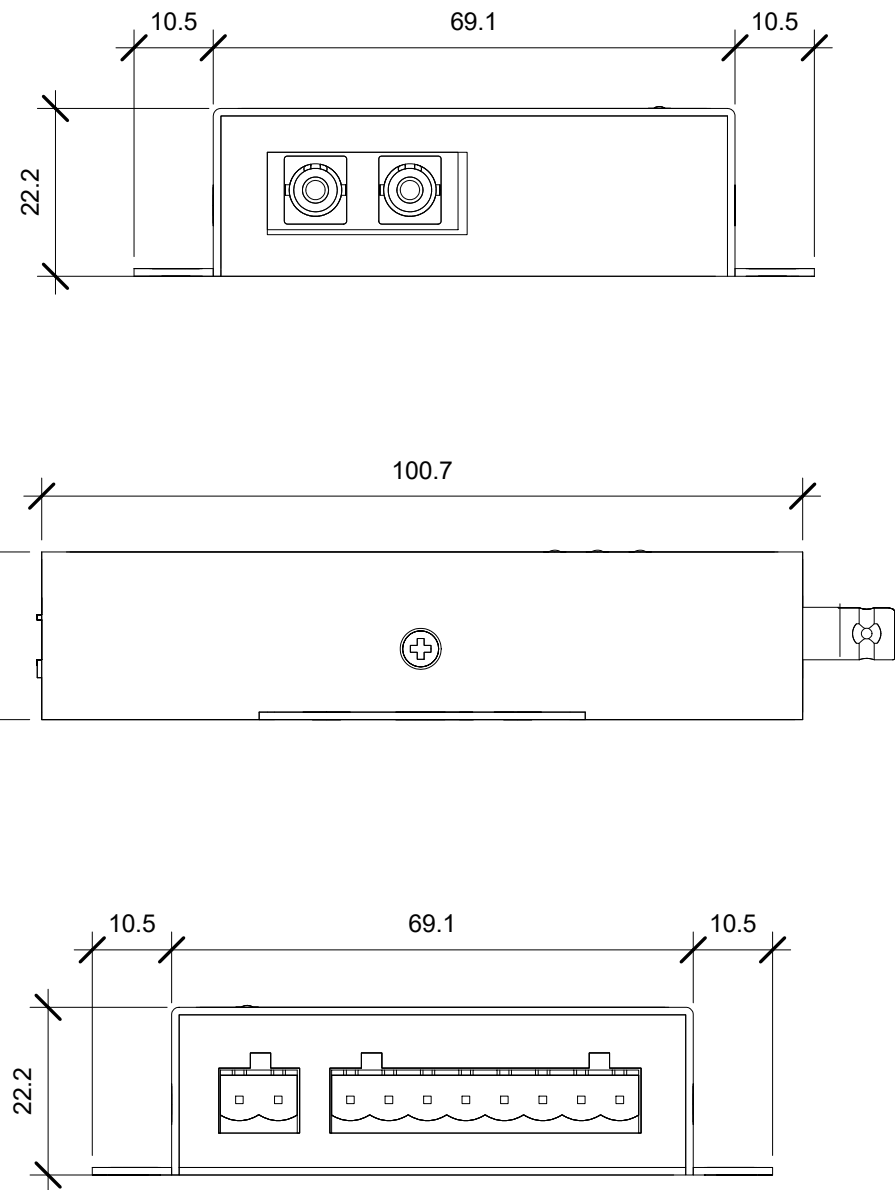
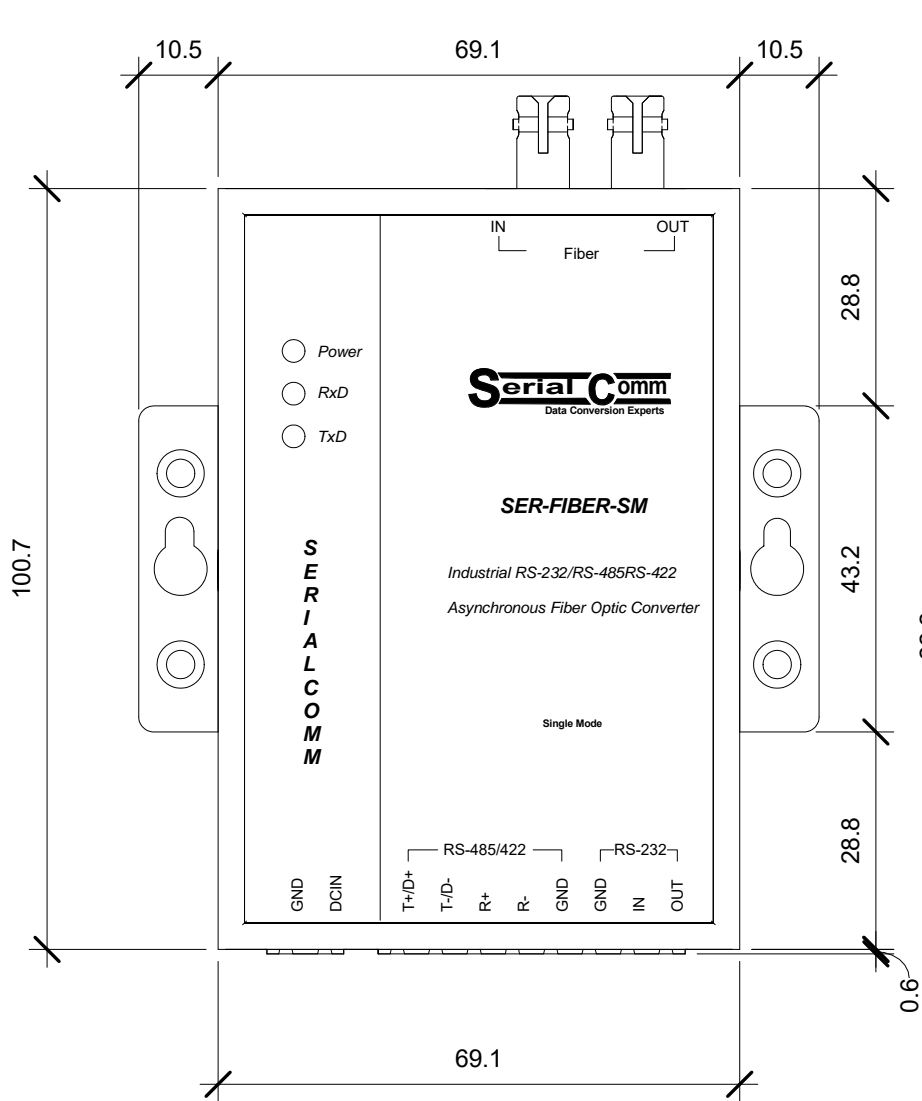

**Serial Comm**®  
Data Conversion Experts

MODEL: SER-FIBER-SM-ST

DESCRIPTION: Industrial RS-232/RS-485/RS-422 to Fiber Optic without Terminal Blocks (SM ST)

SCALE: 1:1

UNIT: mm

ISSUE DATE: 03/05/2017

REV. NO.: 1.00

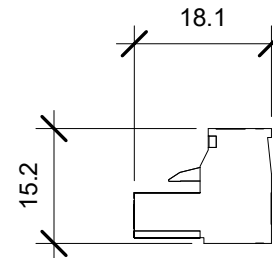
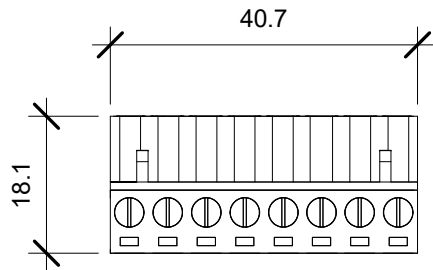
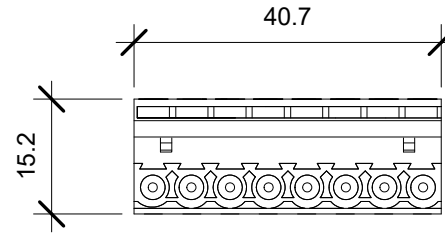
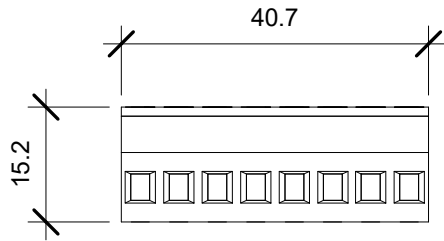

**Serial Comm**®  
Data Conversion Experts

MODEL: SER-FIBER-SM-ST

DESCRIPTION: 8-Position Terminal Block

SCALE: 1:1

UNIT: mm

ISSUE DATE: 03/05/2017

REV. NO.: 1.00

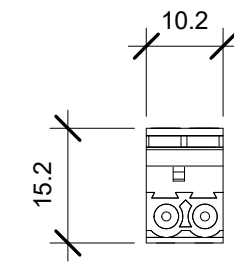
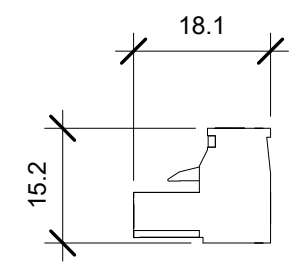
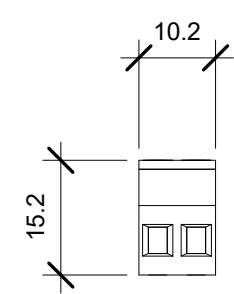
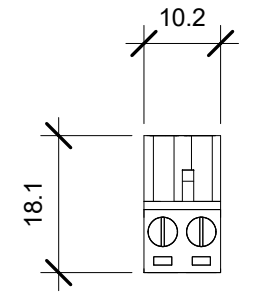

**Serial Comm**®  
Data Conversion Experts

MODEL: SER-FIBER-SM-ST	
DESCRIPTION: 2-Position Terminal Block	
SCALE: 1:1	UNIT: mm
ISSUE DATE: 03/05/2017	REV. NO.: 1.00

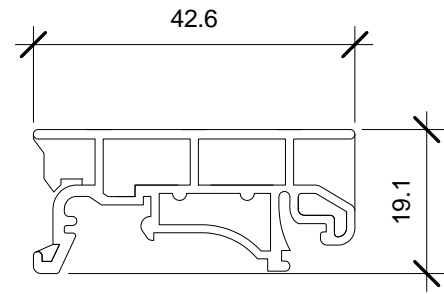
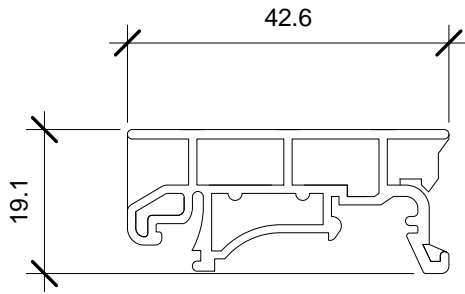
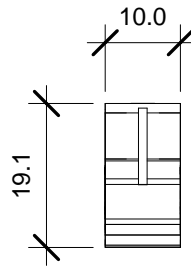
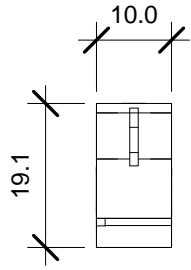
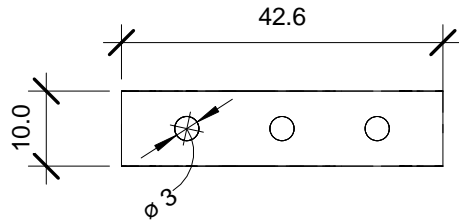

**Serial Comm**®  
Data Conversion Experts

MODEL: DIN Bracket	
DESCRIPTION: Optional DIN Rail Bracket	
SCALE: 1:1	UNIT: mm
ISSUE DATE: 11/08/2016	REV. NO.: 1.00