

## ISO-485-P

### Industrial RS-485 Surge Protector 2-Wire

Datasheet Revision 2.9

[SERIALCOMM.COM](http://SERIALCOMM.COM)

#### GENERAL FEATURES:

- Three stage protection of both lines of the RS-485 port
- Passive: no need for external power
- Plug-and-Play (Device is hot-pluggable)
- Terminal connections for easy installation
- Clamping voltage at 6.8 volts
- 600W of surge protection
- 5-year replacement manufacturer's warranty
- CE, FCC, RoHS and REACH certified



#### DESCRIPTION:

The SerialComm ISO-485-P is an industrial-grade (wide temperature range) bi-directional passive RS-485 surge protector. It can protect any standard half duplex RS-485 port from voltage peaks, spikes caused by lightning and other power surges. The ISO-485-P protects the 2 lines: 485+ and 485-. The unit is passive; therefore, no external power or flow control is required. The ISO-485-P has a 3-wire terminal block on one RS-485 side and a 3-wire terminal block on the other RS-485 side.

The ISO-485-P provides three stages of protection for maximum safety. The first stage is a gas discharge tube. The second stage is a series of protection resistors. The third stage is 600W Transient Voltage Suppressor (TVS). All three stages of protection are provided for each of the RS-485 lines. When the ISO-485-P is placed close to the RS-485 device it is protecting, it will suppress any voltage levels above 6.8 volts without affecting the normal operation of the data transmission. When installing the ISO-485-P it is very important that the ground screws are connected to earth ground with a minimum of 12 AWG copper wire.

#### CERTIFICATIONS:

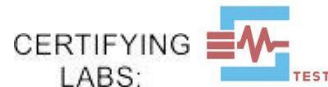

#### FUNCTIONAL DIAGRAM:

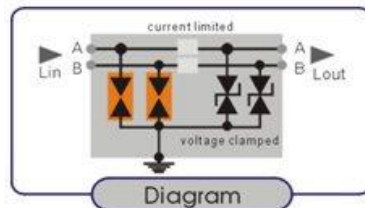

#### PINOUT CONFIGURATION:

##### ISO-485-P INPUT SIDE

SIGNAL	A+	B-	GND
PIN #	A	B	G
FUNCTION	A+	B-	GND

##### ISO-485-P OUTPUT SIDE

SIGNAL	A+	B-	GND
PIN #	A	B	G
FUNCTION	A+	B-	GND

#### SPECIFICATIONS:

COMMUNICATION	
<b>STANDARDS:</b>	2-wire RS-485 Standard
<b>BAUD RATES:</b>	From 300 bps to 1 mbps
<b>CONNECTOR TYPES:</b>	RS-485 Side: 3-wire Terminal Block and Other RS-485 Side: 3-wire Terminal Block
ELECTRICAL	
<b>POWER SOURCE:</b>	Passive Device: No Power Needed.
<b>WORKING VOLTAGE:</b>	0 Volts to 5 Volts
<b>VOLTAGE CLAMP:</b>	6.8V
<b>INSERT CONSUMPTION:</b>	< 0.5 db
<b>DELAY TIME:</b>	< 1 ns
MECHANICAL	
<b>HOUSING:</b>	Heavy Duty Steel Casing
<b>WEIGHT:</b>	0.35oz (10 grams)
<b>DIMENSIONS:</b>	2.76" X 1.02" X 1.02" (70.2 mm X 25.8 mm X 25.8 mm)
ENVIRONMENTAL	
<b>OPERATING TEMP:</b>	-40° F to 185° F (-40°C to 85° C)
<b>STORAGE TEMP:</b>	-40° F to 185° F (-40°C to 85° C)
<b>OPERATING HUMIDITY:</b>	5% To 95% - No Condensation
QUALITY	
<b>PRODUCT SAFETY:</b>	CE, FCC, RoHS and REACH Third-party Certified
<b>QUALITY MANAGEMENT</b>	Manufactured and Distributed to ISO 9001:2015 QMS
<b>RELIABILITY:</b>	Low Failure Rate – 99+% Reliability Since Inception
<b>WARRANTY:</b>	5 Year Replacement Warranty

#### APPLICATIONS:

